

# Xtra Long Life SPDT Switch

50Ω DC to 18 GHz 12 Volt Reflective

## MSP2T-18-12+



Generic photo used for illustration purposes only

CASE STYLE: FK811

Connectors	Model
SMA	MSP2T-18-12+

**+RoHS Compliant**

The +Suffix identifies RoHS Compliance. See our web site for RoHS Compliance methodologies and qualifications

### Maximum Ratings

Operating Temperature	-15°C to +45°C
Storage Temperature	-15°C to +85°C
RF Power (any single port)	10W
Control Voltage	13VDC

Permanent damage may occur if any of these limits are exceeded.

### Features

- low voltage operation, 12V
- low insertion loss, 0.25 dB typ.
- high isolation, 80 dB typ.
- high power handling, 10W
- ultra reliable
- break-before-make configuration
- reflective failsafe switch
- protected by US Patents 5,272,458; 6,414,577; 6,650,210; 7,633,361; 7,843,289

### Applications

- Automatic Test Equipment (ATE)
- reliable "sleeptime" switching
- redundancy switching for microwave radio

### Outline Drawing

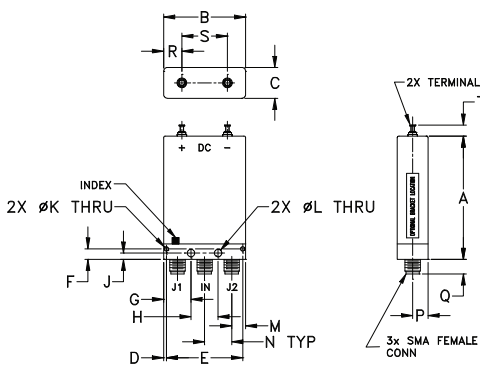

### Outline Dimensions (inch/mm)

A	B	C	D	E	F	G	H	J	K
2.00	1.34	.50	.045	1.240	.170	.445	.440	.103	.070
50.80	34.04	12.70	1.14	31.50	4.32	11.30	11.18	2.62	1.78

L	M	N	P	Q	R	S	T	wt
.120	.230	.440	.25	.24	.297	.740	.19	grams
3.05	5.84	11.18	6.35	6.10	7.54	18.80	4.83	41.0

### Marking Drawing

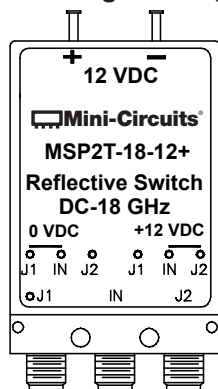

### Electrical Specifications

Parameter	Condition (GHz)	Min.	Typ. (Note 1)	Max.	Unit
<b>Frequency Range</b>		DC	—	18	GHz
<b>Insertion Loss</b>	DC - 1	—	0.10	0.15	dB
	1 - 8	—	0.20	0.30	
	8 - 12	—	0.25	0.35	
<b>Isolation</b>	DC - 1	85	100	—	dB
	1 - 8	75	90	—	
	8 - 12	70	80	—	
<b>VSWR (Note 2)</b>	DC - 1	—	1.05	1.10	:1
	1 - 8	—	1.20	1.35	
	8 - 12	—	1.20	1.35	
<b>DC Current @ +12V (Note 3)</b>	DC - 18	—	180	230	mA
<b>RF Power Cold Switching</b>	DC - 18	—	—	10	W
<b>RF Power Hot Switching</b>	0.1W	10 million	—	—	Cycles
	1.0W	—	1 million	—	

### Notes

1. The performance values represents a common value for the frequency range. For typical performance across the frequency band, see performance graphs in the next page.
2. All ports, all states.
3. +12 Volt applied to energized port, COM is negative.

### Additional Specifications

Operating Voltage Range	12V (nom) ±0.5V
Switching Time (Typ.)	20ms

### Switching States

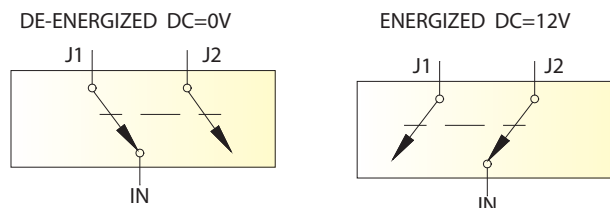

### Notes

- A. Performance and quality attributes and conditions not expressly stated in this specification document are intended to be excluded and do not form a part of this specification document.
- B. Electrical specifications and performance data contained in this specification document are based on Mini-Circuit's applicable established test performance criteria and measurement instructions.
- C. The parts covered by this specification document are subject to Mini-Circuits standard limited warranty and terms and conditions (collectively, "Standard Terms"); Purchasers of this part are entitled to the rights and benefits contained therein. For a full statement of the Standard Terms and the exclusive rights and remedies thereunder, please visit Mini-Circuits' website at [www.minicircuits.com/WCLStore/terms.jsp](http://www.minicircuits.com/WCLStore/terms.jsp)



## Typical Performance Data

FREQ. (MHz)	ON INSERTION LOSS (dB)		OFF ISOLATION (dB)		VSWR, IN (:1)		VSWR (J1, J2) (:1)	
	IN-J1	IN-J2	IN-J1	IN-J2	De- Energized	Energized	(J1) De- Energized	(J2) Energized
10.0	0.00	0.01	85.77	94.22	1.00	1.01	1.01	1.00
100.0	0.01	0.01	102.87	105.34	1.00	1.00	1.00	1.00
1000.0	0.04	0.04	115.37	105.64	1.01	1.01	1.01	1.01
2000.0	0.06	0.06	115.69	98.42	1.02	1.02	1.02	1.02
3000.0	0.07	0.07	107.32	105.01	1.06	1.06	1.06	1.06
4000.0	0.09	0.10	103.20	113.10	1.12	1.12	1.12	1.12
5000.0	0.12	0.12	104.85	109.83	1.18	1.18	1.18	1.18
6000.0	0.13	0.14	102.48	103.47	1.20	1.21	1.21	1.20
7000.0	0.14	0.14	112.75	105.01	1.18	1.19	1.19	1.18
8000.0	0.14	0.14	98.41	96.58	1.14	1.15	1.15	1.14
9000.0	0.13	0.14	96.65	96.81	1.10	1.11	1.11	1.10
10000.0	0.14	0.14	96.31	96.57	1.08	1.08	1.09	1.08
11000.0	0.15	0.16	92.76	93.91	1.09	1.10	1.10	1.10
12000.0	0.17	0.18	88.40	90.44	1.14	1.14	1.14	1.14
13000.0	0.18	0.20	87.03	89.57	1.17	1.18	1.18	1.17
14000.0	0.20	0.21	84.38	85.14	1.18	1.19	1.19	1.18
15000.0	0.20	0.22	82.56	83.98	1.16	1.18	1.18	1.16
16000.0	0.21	0.23	81.52	83.15	1.13	1.16	1.17	1.14
17000.0	0.22	0.24	78.85	80.32	1.13	1.16	1.16	1.15
18000.0	0.24	0.28	75.92	77.77	1.19	1.18	1.19	1.19

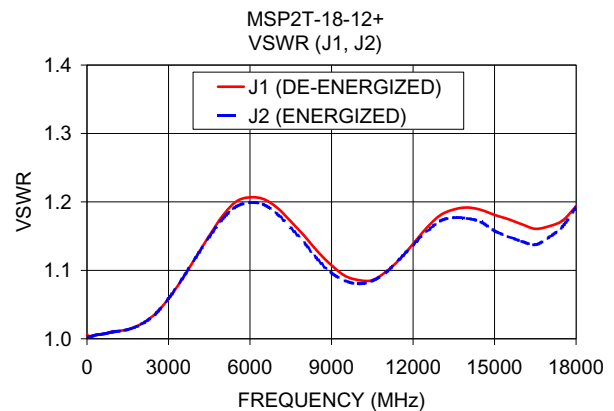
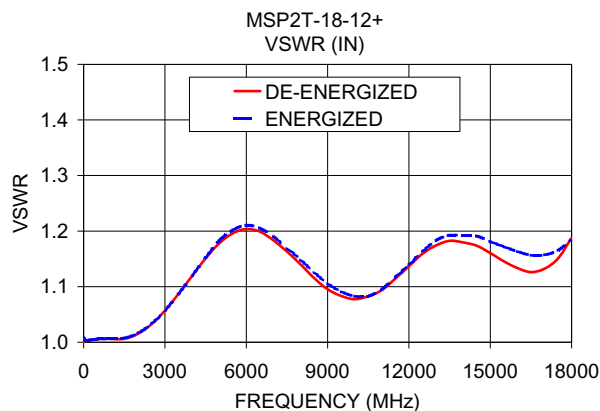
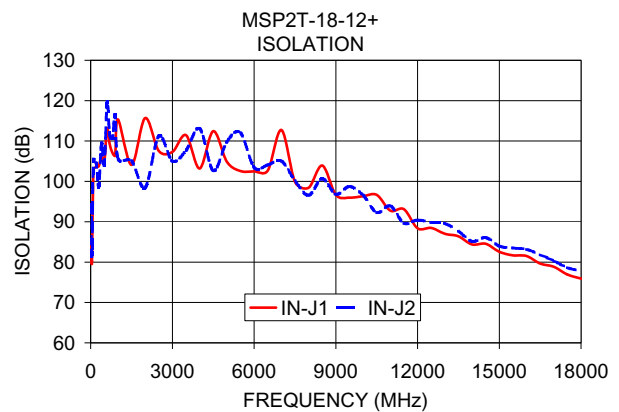
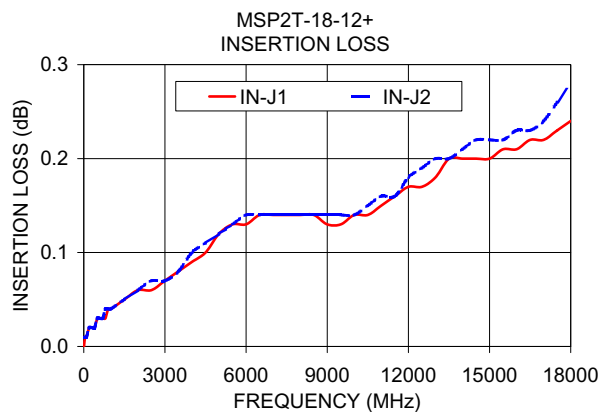

### Notes

- Performance and quality attributes and conditions not expressly stated in this specification document are intended to be excluded and do not form a part of this specification document.
- Electrical specifications and performance data contained in this specification document are based on Mini-Circuit's applicable established test performance criteria and measurement instructions.
- The parts covered by this specification document are subject to Mini-Circuits standard limited warranty and terms and conditions (collectively, "Standard Terms"); Purchasers of this part are entitled to the rights and benefits contained therein. For a full statement of the Standard Terms and the exclusive rights and remedies thereunder, please visit Mini-Circuits' website at [www.minicircuits.com/MCLStore/terms.jsp](http://www.minicircuits.com/MCLStore/terms.jsp)

